



# BMK-21

# Single Mount By-Pass Filter System Installation and Servicing Instructions

### IMPORTANT NOTICE

Read **all** instructions completely before attempting to install this unit. Improper installation could result in serious system and/or equipment damage. The installation of this system is not difficult, however, some mechanical ability is necessary. If you are not comfortable with the instructions or have questions, **do not attempt to install this system**. Consult a mechanic or contact AMSOIL INC. for further instructions or assistance.

If installing on a Japanese- or European-built vehicle utilizing **Metric** or **B.S.P.** threads, additional parts may be required. Consult step D.1 before you continue.

**WARNING:** This filter system is not designed to replace the engine's normal full-flow filter. Do not attempt to install a by-pass filter element in place of the existing full-flow filter.

**WARNING:** Extreme care should be taken to avoid bodily harm during installation. Before starting, ensure the engine is cool to avoid burns and **never** work in the engine compartment area with the engine running.

### A. Getting started

1. Check all parts against the parts list and inspect for damage.
2. Make sure you have the tools needed for the job.

#### Recommended tool list

Adjustable wrench	Torque Wrench	Drill
7/16" wrench	Side Cutter	5/16" drill bit
1/2" wrench	Utility knife	Center punch
9/16" wrench	Adjustable filter wrench	Hammer
1 1/16" wrench	Drain oil pan	Vice

### B. Filter selection

Any of the 3 different sizes of the AMSOIL Spin-On By-Pass Oil Filter elements may be used with this mount. Select the element size according to your vehicle's oil capacity.

Vehicle Oil Capacity	Recommended Element
Up to 9 quarts (5.78" long)	EaBP-90
Up to 15 quarts (7.25" long)	EaBP-100
Up to 21 quarts (10.44" long)	EaBP-110

Service recommendations for these filters are listed later in these instructions. Selecting a larger filter than recommended may extend the service interval, while selecting a smaller filter than recommended may shorten the service interval.

### C. Attaching the filter mount

1. Survey the engine compartment for possible mounting locations. Solid structures such as the firewall, fender well, radiator support or frame are normal locations. (**Do not mount on engine.**) Refer to diagram B for minimum area requirements and consider accessibility for servicing.
2. Refer to diagram A for preferred mounting positions.
3. When the location has been determined, use the mounting template provided to locate and mark mounting holes. This can be easily done with a center punch and hammer.
4. Install adapter fittings (BP-208) on filter mount (BK-303) using provided thread sealant as noted in diagram C. If desired, 90° angle fitting (BP-52) may also be used. Using a 7/16" wrench, tighten fittings 2-3 turns beyond finger tight. Keep in mind the direction you wish to have the hoses intersect the mount.
5. With a 3/16" drill bit, drill out the previously marked mounting holes and attach the mount using the 5/16" bolts, nuts, small washer and fender washers provided. Bolts should be tightened to 16-18 foot pounds. 1/2" wrenches or socket will be required for this operation.
6. Fill the By-Pass Filter element with the same motor oil being used in the vehicle. Lubricate the filter gasket with oil and spin filter onto mount. Tighten per instructions on the filter.

### D. Oil Supply

1. Locate oil pressure sending unit (see diagram E). Remove unit and install "T" (BP-33) using thread sealant as noted in diagram C and tightening 2-3 turns beyond finger tight. **Note:** See diagram G if oil pressure sending unit has a 1/4" N.P.T. thread.

**Note:** Special adapters may be needed to install "T" on some engines. Refer to the Oil Pressure Sending Unit Information Guide. Occasionally, additional fittings may be needed.

2. Reinstall sending unit in one opening of the "T" and a fitting adapter (BP-208) in the other. Use thread sealant and tighten as noted in D.1. Use 90° Street Elbow (BP-52) if necessary, keeping in mind the direction you wish the hose to intersect the fitting.
3. Measure the amount of hose (BP-251) you will need to run from the Oil Pressure Sending Unit "T" to the filter mount fitting labeled **IN**. Additional length will be required to accommodate engine movement during operation. Using a utility knife, squarely cut the hose to the proper length.

**Note:** The hose and fittings supplied with this kit have been matched to provide maximum performance and life expectancy. Interchanging with other types or brands is **not recommended** and **should be avoided**. Should additional hose be required, it may be obtained from your AMSOIL Dealer by ordering part number BP-251.

4. Install hose fittings (BP-261) on both ends of the hose following the instructions noted in diagram F. Tools required are one 9/16" wrench and one 1 1/16" wrench or vise.

**Note:** Do not use any form of thread sealant anywhere on the BP-261 hose fittings.

5. Route and connect the hose assembly making sure the hose does not contact any hot or moving surfaces or sharp edges. Ensure a minimum of a 3/4" bend radius is maintained at all corners. Also, bends in hose should not begin at hose fittings. Using a 9/16" and 7/16" wrench, tighten hose fitting swivel nut to 130-150 inch pounds or from finger tight, rotate an additional 120° or 1/3 of a turn. See diagrams D and H for additional details.

### E. Oil Return

Two options are available for returning the filtered oil to the engine. The first uses a self-tapping hollow bolt (BP-40) and allows the oil to be returned to either the oil pan or a rocker arm/valve cover. The second, which uses an optional swivel fitting (BP-89), returns the oil to the oil filler cap already installed on your vehicle.

1. **Option one:** select either the oil pan or valve cover for installation. **Note:** The self-tapping hollow bolt should be used on stamped metal components only. For oil pan installation, mark a spot approximately 3" above the bottom of the pan. Avoid any pan formations that may suggest an internal obstruction. For the valve cover, choose a mounting location that will not interfere with the movement of internal components and away from the PVC pick-up.
2. Using a punch and hammer, punch a hole in the chosen location between 1/4" (.25") and 5/16" (.3125") in diameter. **Note:** Do not drill this hole as metal fillings are likely to enter the engine and it will produce a weaker attachment of the self-tapping hollow bolt.
3. Using a 9/16" wrench, thread in the self-tapping hollow bolt (BP-40) and sealing gasket (BP-41). As the bolt is tightened, make sure sealing gasket is snug all the way around bolt. Tighten bolt to 6-8 foot pounds.
4. Using a 7/16" and 9/16" wrench, install fitting adapter (BP-208) in self-tapping hollow bolt. Use a 90° Elbow (BP-52) if necessary keeping in mind the direction you wish the hose to intersect the fitting. Use thread sealant provided as noted in diagram C. Tighten 2-3 turns beyond finger tight. Proceed to item 10.

1. **Option two:** remove the existing oil filler cap. Be sure there is not a PVC pick-up in this area.
2. In the center of the cap, drill a 3/8" hole.
3. Install the long threaded portion of the optional return line swivel fitting (BP-89) into the top of the oil filler cap. Secure with the provided self-locking nut and 9/16" wrench.
3. Using thread sealant, install a fitting adapter (BP-208) into the return line swivel fitting. Tighten 2-3 turns beyond finger tight. Reinstall oil filler cap on vehicle. A 90° Elbow (BP-52) may also be used.

4. Measure the amount of hose (BP-251) you will need to run from the self-tapping bolt or optional return line swivel fitting to the filter mount fitting labeled **OUT**. Additional length will be required to accommodate engine movement during operation. Using a utility knife, squarely cut the hose to the proper length.
5. Install hose fittings (BP-261) on both ends of the hose. Follow the instructions noted on diagram F.

**Note:** Do not use any form of thread sealant anywhere on the BP-261 hose fittings.

6. Route and connect the hose assembly making sure the hose does not contact any hot or moving surfaces or sharp edges. Ensure a minimum of a 3/4" bend radius is maintained at all corners and hose bend does not begin at fitting. Tighten hose

fitting swivel nut to 130-150 inch pounds or from finger tight, rotate an additional 120° or 1/3 of a turn. See diagrams D and H for additional details.

- Use plastic ties (BP-46) to secure hoses in position and away from damage. Trim ties, using side cutter.

**Note:** Over tightening the plastic ties may cause the hose to collapse and restrict oil flow.

## F. Start up procedures

- Check that all fittings and hoses are securely attached, and that the hoses are routed properly.
- Check engine oil level. Fill to full mark if necessary.
- Set vehicle parking brake. With transmission in park/neutral start the engine and immediately check oil pressure. **Note:** Pressure may initially take a moment or two to rise.

**Caution:** Carefully check for leaks at fittings, hoses and mount. If leaks are observed, **STOP ENGINE IMMEDIATELY**, repair leaks and continue.

- After engine has warmed, shut off and re-check engine oil level. Fill as necessary.
- Record vehicle mileage/operating hours and date of installation.

## G. Periodic maintenance

- Periodic visual inspection of the fittings and hoses is recommended. Check for leaks, hose deterioration and cuts. Repair and/or replace as necessary.
- Refer to Recommended Filter Change Interval chart for servicing intervals.
- To change the filter element:
  - Ensure engine is off and use caution as the engine, oil and filter may be hot and could result in an injury.
  - Using a filter wrench, remove the filter element. Dispose of properly.
  - Clean the filter gasket contact area on the mount with a clean, lint-free rag.
  - Lubricate the new filter gasket with clean oil.
  - Fill filter as full as possible with engine oil.
  - Screw on new filter, tighten per instructions on the filter.
  - Start engine and check for leaks.
  - Check engine oil level, fill as needed.
  - Record vehicle mileage/operating hours for future reference.

## Mounting Angle Diagram A

(Recommendations are the same right to left and front to back)  
Mounting angle above horizontal is not recommended

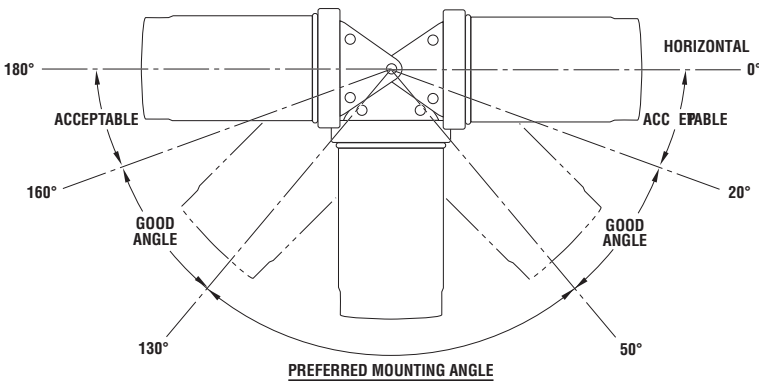

## Diagram C

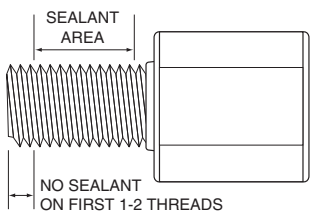

**Note:** If Teflon tape is used, it should be wrapped no more than 1½ to 2 turns in a clockwise direction when viewed from the thread end.

**Caution:** More than two turns of tape may cause distortion or cracking of the port. Never back off (loosen) pipe threaded connectors to achieve alignment.

## Diagram D

Minimum Bend Radius  
(Actual size)

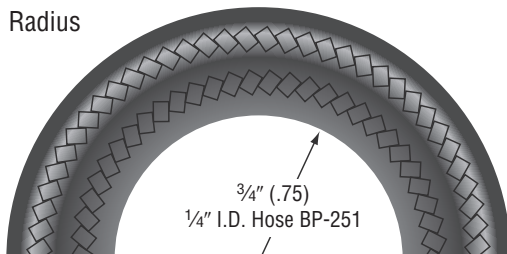

## Parts and assembly list

### Single Mount By-Pass Filter System (BMK-21)

Item	Description	Qty.	Part No.
1.	Oil Pressure Sending Unit (existing)		
2.	Filter Mount Assembly, Spin-On	1	BK-303
3.	Fitting Adapter	4	BP-208
4.	5/16" Fender Washer	3	BP-205
5.	5/16" Flat Washer	3	BP-120
6.	5/16"-18 Self Locking Nut	3	BP-121
7.	5/16"-18 x 1" Hex Head Bolt	3	BP-122
8.	1/4" I.D. Hose	8'	BP-251
9.	Hose Fitting	4	BP-261
10.	Street "T" (1/8" x 1/8" x 1/8")	1	BP-33
11.	Straight "T" (1/4" x 1/4" x 1/4")	1	BP-34
12.	90° Street Elbow, 1/8"	4	BP-52
13.	Bushing 1/8" x 1/4"	1	BP-38
14.	Nipple 1/4" x 2"	1	BP-39
15.	Self Tapping Hollow Bolt	1	BP-40
16.	Sealing Gasket	1	BP-41
	Plastic Tie	2	BP-46
	Thread Sealant	1	BP-198
	Instruction Sheet	1	BP-83

Optional parts available from AMSOIL INC.

Filter Cap for 6.0L Ford	BK-1101
Oil Fill Cap for 6.0L Ford	BK-1102
Oil Filter Sandwich Adapter for GM Duramax	BK-1201
Oil Fill Cap for GM Duramax	BK-1202
Oil Fill Cap for Dodge Cummins	BK-1301
Fitting Adapter 1/8" NPT - 1/4" JIC (stainless)	BP-241
90° Elbow 1/8" NPT - 1/4" JIC	BP-242
Oil Sampling Kit	BP-67
Oil Return Swivel Fitting	BP-89
Deluxe Oil Sampling Valve 1/4" NPT	G-1570

## Diagram G

Optional installation  
at Oil Sending  
Location (for 1/4")

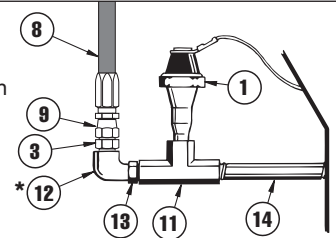

## Diagram B

MINIMUM AREA  
NEEDED FOR  
MOUNT AND OIL  
FILTER ELEMENT

\* Mount and element  
heights plus 1-inch  
removal clearance

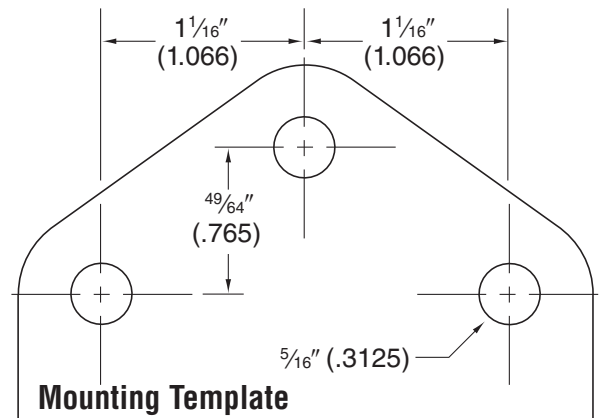
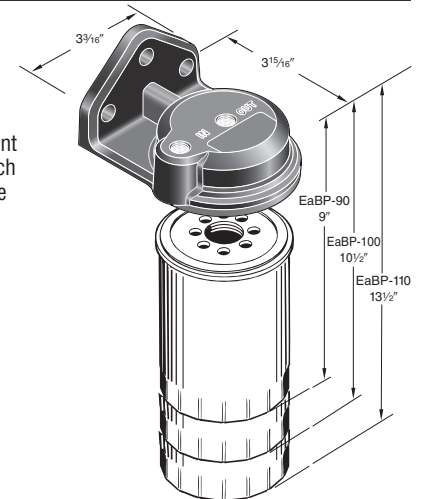

Mounting Template

## Diagram E

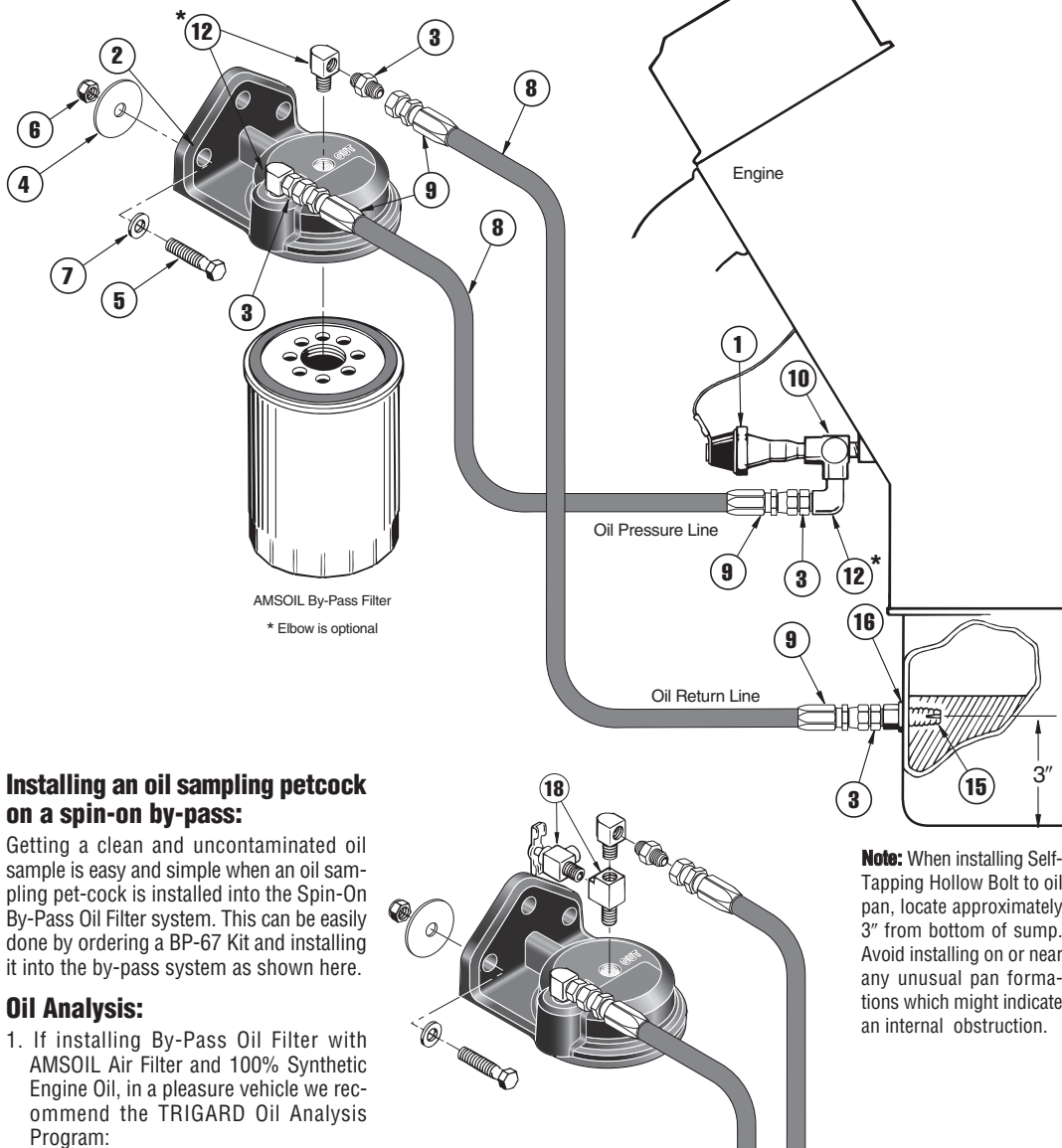

### Installing an oil sampling petcock on a spin-on by-pass:

Getting a clean and uncontaminated oil sample is easy and simple when an oil sampling pet-cock is installed into the Spin-On By-Pass Oil Filter system. This can be easily done by ordering a BP-67 Kit and installing it into the by-pass system as shown here.

### Oil Analysis:

- If installing By-Pass Oil Filter with AMSOIL Air Filter and 100% Synthetic Engine Oil, in a pleasure vehicle we recommend the TRIGARD Oil Analysis Program:
  - TRIGARD 1 (Stock No. ATG-01) is the starter program. It contains registration material and 2 **prepaid** analysis to check oil's condition.
  - TRIGARD 2 (ATG-02) is for all subsequent oil samples. Each ATG-02 also contains materials for 2 prepaid oil analysis.
- For other oil analysis or commercial vehicles, order G-1318 Oil Analysis Sampling Kits (in U.S., Canada). Consult AMSOIL Technical Service for details.

### By-Pass oil filter return-line fitting:

A swivel fitting can be installed directly on your oil filler cap for the oil return-line from the AMSOIL By-Pass Filter. This fitting can be used (in most cases) instead of the self-tapping hollow bolt, which is usually installed on the oil pan.

The Return-Line Fitting is made of a sturdy brass-alloy and is constructed so that the top of the fixture can swivel. This makes it easy to take off your oil cap. The installation of the fitting is simple and generally takes 5-10 minutes. Order BP-89. Be sure there is not a PCV pick-up in this area.

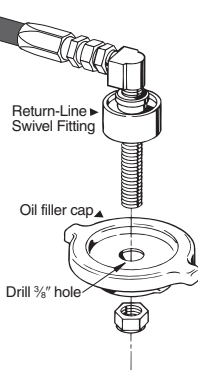

## Diagram F

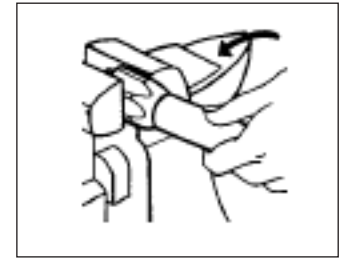

- Place socket in vice and screw in hose counter-clockwise until hose bottoms. Back hose out 1/2 turn.

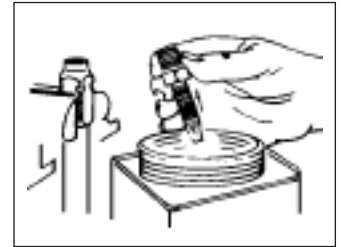

- Oil inside of hose and nipple threads liberally with oil. Do not oil hose cover.

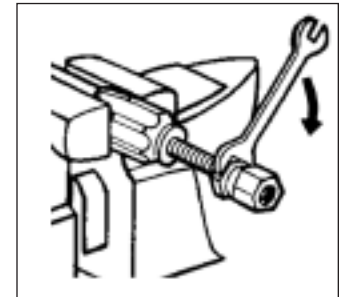

- Screw nipple assembly into socket using wrench on nipple hex until nipple hex shoulders against socket.

**Note:** When installing Self-Tapping Hollow Bolt to oil pan, locate approximately 3" from bottom of sump. Avoid installing on or near any unusual pan formations which might indicate an internal obstruction.







### Oil Sending Unit Information Guide

Vehicle	Year	Adapter Info.	Vehicle	Year	Adapter Info.
AMC (except Renault)	All	1	Peugot		
AUDI Fox, 100, 4000, 5000 Diesel, Turbo	All	3	404 (to 1976), 505 (after 1976), 504	All	5
Alfa Romeo			Diesels, Turbo, 604, V-6 gas	All	3
1600, 1750, 2000, Alfetta, Spider, Veloce	All	3	Plymouth (except)	All	1
Alfa Sud	All	5	Champ, Arrow, Sapparo	1976-81	2
BMW			Pontiac (except)	All	1
2500, 2800, 520, 1600-2, 2002	To 1975	3	Firefly, Sunburst	1985-88	2
320, 6333, 733, 530	1975-81	4	Porche		
All models	1982-83	4	356, 6-V, 12V, 911, 912, 914C Carrera	All	3
Buick (except Opel)	All	1	914-4	All	1
Cadillac, All	All	1	928, 944	All	6
Chevrolet (except)	All	1	Renault		
Luv, 1800cc, Sprint, Spectrum	1976-88	2	LeCar, Alliance	All	5
Nova	1985-88	2	Fuego	All	3
Chrysler, All	All	1	SAAB		
Datsun, All	All	2	Sonnet, 96, 900, Turbo	All	1
Dodge (except)	All	1	99	All	3
Colt	To 1976	2	Subaru, All	All	2
Colt, Challenger	1976-81	2	Toyota, All	All	2
FIAT			Triumph, Spitfire, TR-7, TR-8	All	1
Strada, 128, 131, 132, X 1/9	All	5	Volkswagen (except)	All	3
123	All	4	Type 4	All	6
Ford (except)	All	1	Volvo (except)	All	3
Courier, 1800cc eng.	1972-79	2	Some 262c, 246GL, 265 GL-V6	Some	6
Honda, Prelude, Civic, Accord	All	2			
Lincoln, All	All	1			
Mazda, All	All	2			
Mercedes, Benz, All	All	6			
Mercury, All	All	1			
MG, MGA, MGB, Midglet	All	1			
Oldsmobile, All	All	1			
Opel, GT1100, GT1900, Manta	All	5			

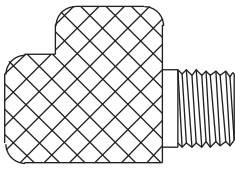
- Adapter supplied in installation kit.
- 1/8 x 28 BSP to 1/8" NPT (Order AMSOIL BP-44 adapter kit).
- 10 x 1MM to 1/8" or 1/4" NPT (Order AMSOIL BP-45 adapter kit).
- 12 x 1.5MM to 1/8" or 1/4" NPT (Purchase from outside source).\*
- 14 x 1.5MM to 1/8" or 1/4" NPT (Purchase from outside source).
- Information not available, contact vehicle manufacturer.

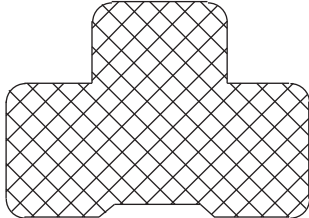
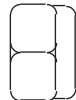
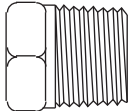
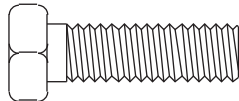
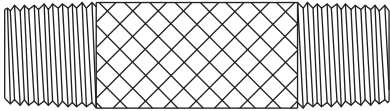
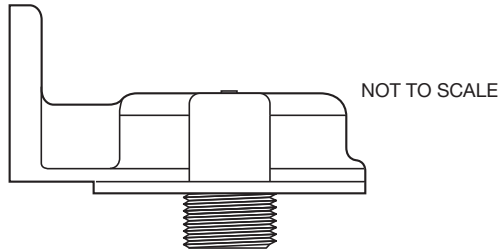
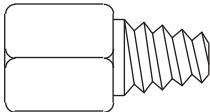
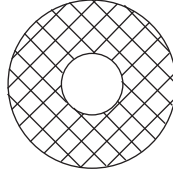
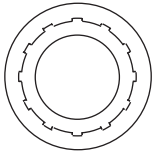
\*Note: Two adapters required, 1 male to female, and 1 female to male.

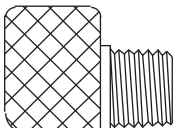
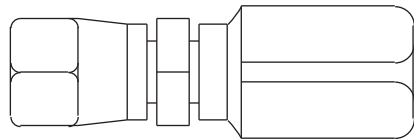
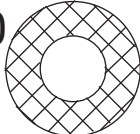
# BMK-21 PARTS IDENTIFICATION SHEET

- |                                     |   |                                      |   |
|-------------------------------------|---|--------------------------------------|---|
| (1) BP-33<br>1/8" STREET<br>"T"     |    | (2) BP-46<br>PLASTIC TIE             |    |
| (1) BP-34<br>1/4" STRAIGHT<br>"T"   |    | (3) BP-121<br>5/16" NUT              |    |
| (1) BP-38<br>1/8" x 1/4"<br>BUSHING |    | (3) BP-122<br>5/16" x 1" BOLT        |    |
| (1) BP-39<br>1/4" x 2" BUSHING      |  | (1) BK-303<br>FILTER MOUNT           |   |
| (1) BP-40<br>HOLLOW BOLT            |  | (3) BP-205<br>5/16" FENDER<br>WASHER |  |
| (1) BP-41<br>SEALING<br>GASKET      |  | (8) BP-251<br>1/4" I.D. HOSE         |  |
| (4) BP-52<br>90° ELBOW<br>1/8"      |  | (4) BP-261<br>1/4" HOSE FITTING      |  |
| (3) BP-120<br>5/16" WASHER          |  | (4) BP-208<br>FITTING ADAPTER        |  |

## **AMSOIL By-Pass Warranty**

AMSOIL INC. warrants each AMSOIL By-pass System to be free from defects in material and workmanship for a period of one year from the time of purchase. **THIS WARRANTY DOES NOT APPLY IF THE BY-PASS SYSTEM HAS BEEN IMPROPERLY INSTALLED, ABUSED, DAMAGED, USED IN COMPETITIVE RACING OR ON MODIFIED ENGINES OR IF USED IN ANY AIRCRAFT OF AVIATION APPLICATION. AMSOIL INC. DOES NOT MAKE BY-PASS RECOMMENDATIONS FOR AIRCRAFT OR AVIATION USE.** If your AMSOIL By-pass System is found to be defective within a period of one year from the time of purchase, AMSOIL INC. will replace the By-pass System or defective component with another AMSOIL By-pass System or component or refund or credit the AMSOIL Dealer's or customer's account. AMSOIL will reimburse you for the reasonable costs of the parts and labor required to repair your engine or equipment to the extent the damage was solely attributable to a defect in your AMSOIL By-pass System. In order to obtain engine or equipment repairs under this warranty the Dealer or customer must directly contact AMSOIL Technical Service, AMSOIL INC., 1101 Susquehanna Ave., Superior WI 54880, Tel: 715-399-TECH (8324). The customer must also allow the AMSOIL Technical Services Department to examine the By-pass System or Filter(s) and, if required, the engine or equipment, to determine the extent of damage and whether it was caused by a defective AMSOIL By-pass System or Filter(s). The By-pass System and Filter(s) must be returned, in its original, undamaged condition, to the AMSOIL Technical Service Department for examination. This warranty is exclusive of any other warranty, express or implied. **AMSOIL BY-PASS SYSTEMS EXPRESSLY DISCLAIMS, WITHOUT LIMITATION, THE IMPLIED WARRANTIES OF MERCHANTABILITY AND OF FITNESS FOR A PARTICULAR PURPOSE.** The foregoing states the entire AMSOIL By-pass System's exclusively liability and the buyer's exclusive and sole remedy for any damages or claim made in connection with the sale of an AMSOIL By-pass System. AMSOIL By-pass Systems shall in no event be liable for any special, incidental, or consequential damages whatsoever, except those specifically provided for in this warranty. Some states do not allow the exclusion or limitation of incidental or consequential damages, so the above limitations or exclusion may not apply to you. This warranty gives you specific legal rights and you may also have other rights, which vary from state to state.

## Diagram H Hose routing examples

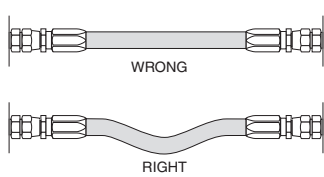

### 1. Provide for length change

In straight hose installations allow enough slack in the hose line to provide for changes in length that will occur when pressure is applied. This change in length can be from +2% to -4%.

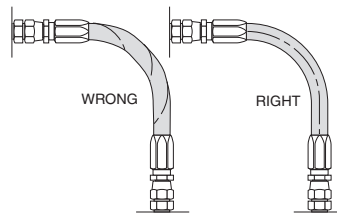

### 2. Avoid twisting and orient properly

Do not twist hose during installation. This can be determined by the printed layline on the hose. Pressure applied to a twisted hose can cause hose failure or loosening of connections.

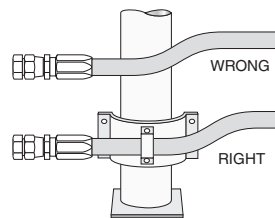

### 3. Protect from hazardous environment

Keep hose away from hot parts. High ambient temperature will shorten hose life. If you can not route it away from the heat source, insulate it.

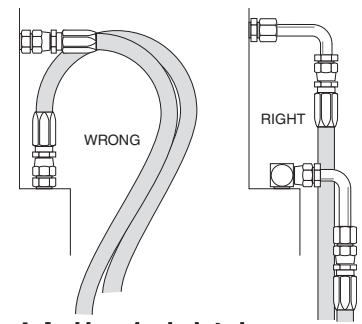

### 4. Avoid mechanical strain

Use elbows and adapters in the installation to relieve strain on the assembly, and to provide easier and neater installations that are accessible for inspection and maintenance.

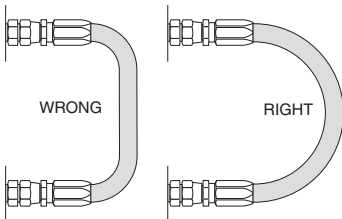

### 5. Use proper bend radius

Keep the bend radius of the hose as large as possible to avoid collapsing of the hose and restriction of flow. Follow catalog specs on minimum bend radii.

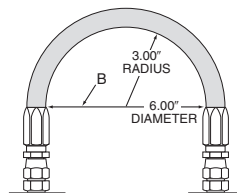

### 6. Use proper bend radius (cont.)

Maximum bend radius is measured on the inside bend of the hose. To determine minimum bend, divide the total distance between ends (B length) by 2. For example B = 6, minimum bend radius = 3.

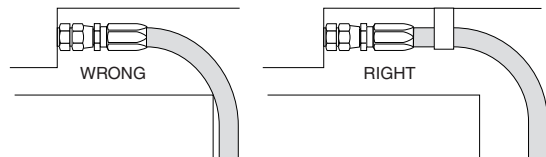

### 7. Secure for protection

Install hose runs to avoid rubbing or abrasion. Use clamps to support long runs of hose or to keep hose away from moving parts. It is important that the clamps do not allow the hose to move. This movement will cause abrasion and premature hose failure.

### 8. Avoid Improper Hose Movement

Make sure relative motion of the machine components produces bending rather than twisting of the hose. Hose should be routed so that the flex is in the same plane as the equipment movement.

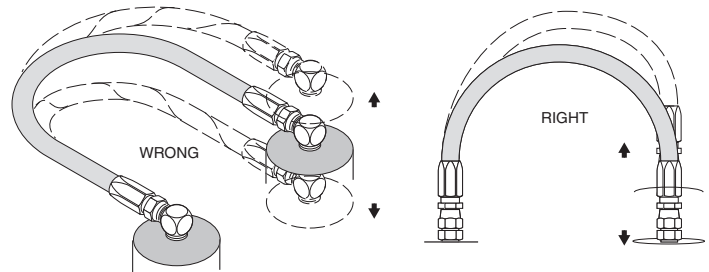

## AMSOIL Oil Filter Change Recommendations

### Vehicles with Gasoline or Diesel Fueled Engines

- **EaO and Donaldson Endurance ELF 7349** (Dodge Cummins 5.9L): Up to 25,000 miles (15,000 miles for severe service) or one-year service life, whichever comes first, when used in conjunction with AMSOIL Synthetic oil. Always change oil filter at time of oil change.
- **EaBP By-pass Filters:** Should be changed every other full flow filter change up to 60,000 miles, whichever comes first. When used with other brands of motor oil or full flow filters, the EaBP should be changed every other full flow filter change. AMSOIL recommends using oil analysis when extending oil drain intervals.
- **Donaldson Endurance:** Heavy-duty commercial vehicles and off road equipment, when used in conjunction with AMSOIL Synthetic oil, up to two times longer than OEM\* recommendations, not to exceed 60,000 miles for on-highway diesel applications. Always change oil filter at the time of oil change.
- **WIX OEM\*:** Recommendations extended to match drain intervals of AMSOIL XL motor oils.

### Stationary Engines

- **EaO and Donaldson Endurance:** Up to two times longer than OEM\* recommendations. Always change oil filter at time of oil change.
- **WIX and Donaldson "P" Series:** OEM\* Recommendations.

\*OEM: Original Equipment Manufacturer

To order By-Pass Oil Filter Parts or oil sample kits, consult your AMSOIL Dealer or the AMSOIL Product Price List for your country.